



Printer/Scanner Unit Type 2105



Operating Instructions Printer Reference 2



-
- 1 Setting Up the Printer Driver and Cancelling a Print Job
 - 2 Using the Document Server
 - 3 Sample Print/Locked Print
 - 4 Troubleshooting
 - 5 Printer Features
 - 6 Appendix

Introduction

This manual describes detailed instructions on the operation and notes about the use of this machine. To get maximum versatility from this machine all operators are requested to read this manual carefully and follow the instructions. Please keep this manual in a handy place near the machine.

Important

Contents of this manual are subject to change without prior notice. In no event will the company be liable for direct, indirect, special, incidental, or consequential damages as a result of handling or operating the machine.

Warning:

Use of controls or adjustment or performance of procedures other than those specified in this manual might result in hazardous radiation exposure.

Trademarks

Microsoft®, Windows® and Windows NT® are registered trademarks of Microsoft Corporation in the United States and/or other countries.

Adobe®, PostScript®, Acrobat® are registered trademarks of Adobe Systems Incorporated.

PCL® is a registered trademark of Hewlett-Packard Company.

AppleTalk, Apple, Macintosh and Mac are registered trademarks of Apple Computer, Incorporated.

IPS-PRINT™ Printer Language Emulation Copyright©2000, Oak Technology, Inc., All Rights Reserved.

Ethernet® is a registered trademark of Xerox Corporation.

UNIX is a registered trademark in the United States and other countries, licensed exclusively through X/Open Company Limited.

Other product names used herein are for identification purposes only and might be trademarks of their respective companies. We disclaim any and all rights in those marks.

The proper names of the Windows operating systems are as follows:

- The product name of Windows® 95 is Microsoft®Windows® 95
- The product name of Windows® 98 is Microsoft®Windows® 98
- The product name of Windows® Me is Microsoft®Windows®Millennium Edition (Windows Me)
- The product name of Windows® XP are as follows:
Microsoft®Windows® XP Professional
Microsoft®Windows® XP Home Edition
- The product name of Windows® 2000 are as follows:
Microsoft® Windows® 2000 Advanced Server
Microsoft® Windows® 2000 Server
Microsoft® Windows® 2000 Professional
- The product name of Windows® NT are as follows:
Microsoft® Windows NT® Server 4.0
Microsoft® Windows NT® Workstation 4.0
- Microsoft® Windows NT® Workstation operating system Version 4.0

Notes:

Some illustrations in this manual might be slightly different from the machine.

Certain options might not be available in some countries. For details, please contact your local dealer.

Manuals for This Machine

The following manuals describe the operational procedures of this machine. For particular functions, see the relevant parts of the manual.

Note

- Manuals provided are specific to machine type.
- Adobe Acrobat Reader is necessary to view the manuals as a PDF file.
- Two CD-ROMs are provided:
 - CD-ROM 1 “Operating Instructions for Printer/Scanner”
 - CD-ROM 2 “Scanner Driver & Document Management Utilities”

❖ **General Settings Guide**

Provides an overview of the machine.

It also describes System Settings (such as paper trays and user codes settings), Document Server functions, and troubleshooting.

❖ **Network Guide (PDF file - CD-ROM1)**

Describes procedures for configuring the machine and computers in a network environment.

❖ **Copy Reference**

Describes operations, functions, and troubleshooting for the machine's copier function.

❖ **Printer Reference 1**

Describes system settings and operations for the machine's printer function.

❖ **Printer Reference 2 (PDF file - CD-ROM1) (this manual)**

Describes operations, functions, and troubleshooting for the machine's printer function.

❖ **Scanner Reference (PDF file - CD-ROM1)**

Describes operations, functions, and troubleshooting for the machine's scanner function.

❖ **Manuals for DeskTopBinder V2 Lite**

DeskTopBinder V2 Lite is a utility included on the CD-ROM labeled “Scanner Driver & Document Management Utilities”.

- DeskTopBinder V2 Lite Setup Guide (PDF file - CD-ROM2)
Describes installation of, and the operating environment for DeskTopBinder V2 Lite in detail. This guide can be displayed from the **[Setup]** dialog box when DeskTopBinder V2 Lite is installed.
- DeskTopBinder V2 Lite Introduction Guide (PDF file - CD-ROM2)
Describes operations of DeskTopBinder V2 Lite and provides an overview of its functions. This guide is added to the **[Start]** menu when DeskTopBinder V2 Lite is installed.
- Auto Document Link Guide (PDF file - CD-ROM2)
Describes operations and functions of Auto Document Link installed with DeskTopBinder V2 Lite. This guide is added to the **[Start]** menu when DeskTopBinder V2 Lite is installed.

❖ **Manuals for ScanRouter V2 Lite**

ScanRouter V2 Lite is a utility included on the CD-ROM labeled “Scanner Driver & Document Management Utilities”.

- ScanRouter V2 Lite Setup Guide (PDF file - CD-ROM2)
Describes installation of, settings, and the operating environment for ScanRouter V2 Lite in detail. This guide can be displayed from the **[Setup]** dialog box when ScanRouter V2 Lite is installed.
- ScanRouter V2 Lite Management Guide (PDF file - CD-ROM2)
Describes delivery server management and operations, and provides an overview of ScanRouter V2 Lite functions. This guide is added to the **[Start]** menu when ScanRouter V2 Lite is installed.

❖ **Other manuals**

- PS3 Supplement (PDF file - CD-ROM1)
- Unix Supplement (Available from an authorized dealer, or as a PDF file on our Web site.)

TABLE OF CONTENTS

Manuals for This Machine	i
How to Read This Manual	1

1. Setting Up the Printer Driver and Cancelling a Print Job

Accessing the Printer Properties	3
Windows 95/98/Me - Accessing the Printer Properties	3
Windows 2000/XP - Accessing Printer Properties	4
Windows NT 4.0 - Accessing the Printer Properties	5
Macintosh - Setting Up for Printing	7
Cancelling a Print Job	8
Windows - Cancelling a Print Job	8
Macintosh - Cancelling a Print Job.....	9

2. Using the Document Server

Accessing the Document Server.....	11
---	-----------

3. Sample Print/Locked Print

Sample Print.....	13
Printing a Sample Print File.....	13
Deleting a Sample Print File.....	15
Locked Print	16
Printing a Locked Print File	16
Deleting Locked Print Files	18
Checking the Error Log.....	19
Displaying Spooled Job List.....	20
Deleting Spooled Print Jobs.....	20
Form Feed.....	21
Print using a selected tray.....	21
Canceling the form feed	21

4. Troubleshooting

Error & Status Messages on the Display Panel	23
The Machine Does Not Print	24
Other Printing Problems	27

5. Printer Features

Printer Features Menu	31
Adjusting Printer Features	33
Printer Features Parameters	34
List/Test Print	34
Maintenance	37
System	38
Host Interface	41
PCL Menu	41
PS Menu	43

6. Appendix

Finisher	45
Staple	46
Staple Position	46
Precaution on stapling	48
Punch	49
Punch Position	49
Precautions when punching	50
Collate	51
Spool Printing	53
Covers	55
Slip Sheets	57
Chaptering	59
User Defined Pages	61
Separation Sheet	62
Specifications	63
Options	64
INDEX	67

How to Read This Manual

Symbols

In this manual, the following symbols are used:

 **WARNING:**

This symbol indicates a potentially hazardous situation which, if instructions are not followed, could result in death or serious injury.

 **CAUTION:**

This symbol indicates a potentially hazardous situation which, if instructions are not followed, may result in minor or moderate injury or damage to property.

* The statements above are notes for your safety.

 **Important**

If this instruction is not followed, paper might misfeed, originals might be damaged, or data might be lost. Be sure to read this.

 **Preparation**

This symbol indicates prior knowledge or preparations is required before operation.

 **Note**

This symbol indicates precautions for operation, or actions to take after mal-operation.

 **Limitation**

This symbol indicates numerical limits, functions that cannot be used together, or conditions in which a particular function cannot be used.

 **Reference**

This symbol indicates a reference.

[]

Keys and buttons that appear on the computer's display.

Keys that appear on the machine's display panel.

[]

Keys built into the machine's control panel.

Keys on the computer's keyboard.

1. Setting Up the Printer Driver and Cancelling a Print Job

Accessing the Printer Properties

Windows 95/98/Me - Accessing the Printer Properties

Changing default settings

- 1** On the taskbar, click the **[Start]** button, point to **[Settings]**, and then click **[Printers]**.

The **[Printers]** window appears.

- 2** Click the icon of the machine whose default you want to change.

- 3** On the **[File]** menu, click **[Properties]**.

The **[Printer Properties]** dialog box appears.

- 4** Make the settings you require, and then click **[OK]**.

 **Note**

- With some applications, the printer driver settings are not used, and the application own settings are applied.

Making settings from an application

To make settings for a specific application, open the **[Printer Properties]** dialog box from that application. The following example describes how to make settings for the WordPad application that comes with Windows 95/98/Me.

 **Note**

- Actual procedures you should follow to open the **[Printer Properties]** dialog box may vary depending on the application. For more information, see the operating instructions that comes with the application you are using.
- Any settings you make in the following procedure are valid for the current application only:

- 1** On the **[File]** menu, click **[Print]**.

The **[Print]** dialog box appears.

- 2** Select the machine you want to use in the **[Name]** list box, and then click **[Properties]**.

The **[Printer Properties]** dialog box appears.

- 3** Make the settings you require, and then click **[OK]**.

- 4** Click **[OK]** to start printing.

Windows 2000/XP - Accessing Printer Properties

Changing default settings - Printer Properties

 **Limitation**

- Changing machine settings requires Manage Printers permission. Members of the Administrators and Power Users groups have Manage Printers permission by default. When you set up options, log on using an account that has Manage Printers permission.

- 1** On the taskbar, click the [Start] button, point to [Settings], and then click [Printers].

The [Printers] window appears.

 **Note**

- In Windows XP Professional, access the [Printers and Faxes] window from the [Start] button on the taskbar.
- In Windows XP Home Edition, access the [Printers and Faxes] window by clicking [Control Panel] from the [Start] button on the taskbar, click [Printers and Other Hardware], and then click [Printers and Faxes].

- 2** Click the icon of the machine whose default you want to change.

- 3** On the [File] menu, click [Properties].

The [Printer Properties] dialog box appears.

- 4** Make the settings you require, and then click [OK].

 **Note**

- Normally you do not have to change the “Form to Tray Assignment” settings on the [Device Settings] tab in the PostScript 3 printer driver.
- Settings you make here are used as default for all applications.

Changing default settings - Printing Preferences Properties

 **Limitation**

- Changing machine settings requires Manage Printers permission. Members of the Administrators and Power Users groups have Manage Printers permission by default. When you set up options, log on using an account that has Manage Printers permission.

- 1** On the taskbar, click the [Start] button, point to [Settings], and then click [Printers].

The [Printers] window appears.

 **Note**

- In Windows XP Professional, access the [Printers and Faxes] window from the [Start] button on the taskbar.
- In Windows XP Home Edition, access the [Printers and Faxes] window by clicking [Control Panel] from the [Start] button on the taskbar, click [Printers and Other Hardware], and then click [Printers and Faxes].

- 2** Click the icon of the machine whose default you want to change.

- 3** On the **[File]** menu, click **[Printing Preferences...]**.

The **[Printing Preferences Properties]** dialog box appears.

- 4** Make the settings you require, and then click **[OK]**.

 **Note**

- Settings you make here are used as default for all applications.

Making settings from an application

To make settings for a specific application, open the **[Print]** dialog box from that application. The following example describes how to make settings for the WordPad application that comes with Windows 2000/XP.

 **Note**

- Actual procedures you should follow to open the **[Print]** dialog box vary depending on the application. For more information, see the operating instructions that comes with the application you are using.
- Any settings you make in the following procedure are valid for the current application only.

- 1** On the **[File]** menu, click **[Print...]**.

The **[Print]** dialog box appears.

- 2** Select the machine you want to use in the **[Select Printer]** box.

Click the tab for which you want to change print settings.

 **Note**

- In Windows XP, click **[Preference]** to open the Printing Preference window.

- 3** Make the settings you require, and then click **[OK]**.

- 4** Click **[OK]** to start printing.

 **Note**

- In Windows XP, click **[Print]** to start printing.

Windows NT 4.0 - Accessing the Printer Properties

Changing default settings - Printer Properties

 **Limitation**

- Changing machine settings requires Full Control access permission. Members of Administrators, Server Operators, Print Operators, and Power Users groups have Full Control permission by default. When you set up options, log on using an account that has Full Control permission.

- 1** On the taskbar, click the **[Start]** button, point to **[Settings]**, and then click **[Printers]**.

The **[Printers]** window appears.

- 2** Click the icon of the machine whose default you want to change.

- 3** On the **[File]** menu, click **[Properties]**.

The **[Printer Properties]** dialog box appears.

4 Make the settings you require, and then click [OK].

 **Note**

- Normally you do not have to change the “Form to Tray Assignment” settings on the [Device Settings] tab in the PostScript 3 printer driver.
- Settings you make here are used as default for all applications.

Changing the default settings - Default Document Properties

 **Limitation**

- Changing machine settings requires Full Control access permission. Members of the Administrators, Server Operators, Print Operators, and Power Users groups have Full Control permission by default. When you set up options, log on using an account that has Full Control permission.

1 On the taskbar, click the [Start] button, point to [Settings], and then click [Printers].

The [Printers] window appears.

2 Click the icon of the machine whose default you want to change.

3 On the [File] menu, click [Document Defaults].

The [Default Document Properties] dialog box appears.

4 Make the settings you require, and then click [OK].

 **Note**

- Settings you make here are used as default for all applications.

Making settings from an application

To make settings for a specific application, open the [Printer Properties] dialog box from that application. The following example describes how to make settings for the WordPad application that comes with Windows NT 4.0.

 **Note**

- Actual procedures you should follow to open the [Printer Properties] dialog box vary depending on the application. For more information, see the operating instructions that comes with the application you are using.

- Any settings you make in the following procedure are valid for the current application only.

1 On the [File] menu, click [Print].

The [Print] dialog box appears.

2 Select the machine you want to use in the [Name] list box, and then click [Properties].

The [Printer Properties] dialog box appears.

3 Make the settings you require, and then click [OK].

4 Click [OK] to start printing.

Macintosh - Setting Up for Printing

Making paper settings from an application

- 1** Open the file you want to print.
- 2** On the [File] menu, click [Page Setup].
The [AdobePS Page Setup] dialog box appears.
- 3** Make sure that the machine you want to use is shown in the [Format for:] box.

Note

- In Mac OS X, this is called [Paper Size].
- If the machine is not shown in the [Format for:] box, use the pop-up menu to display a list of available machines.

Reference

The actual appearance of the Page Setup depends on the application you are using. See the operating instructions that comes with the Macintosh for more information.

- 4** In the [Paper:] box, select the paper size.
- 5** Make the settings you require, and then click [OK].

Setting up for printing from an application

- 1** Open the file you want to print.
- 2** On the [File] menu, click [Print].
The [Printer Features] dialog box appears.
- 3** Make sure that the machine is selected in the [Printer:] box.
- 4** Make the settings you require, and then click [Print] to start printing.

Cancelling a Print Job

1

Windows - Cancelling a Print Job

1 Double-click the printer icon on the Windows taskbar.

A window appears, showing all print jobs currently queued for printing. Check the current status of the job you want to cancel.

2 Select the name of the job you want to cancel.

3 On the [Document] menu, click [Cancel Printing].

Note

- In Windows XP, click [cancel] on the [Document] menu.
- In Windows 95/98/Me, 2000 or NT 4.0, you can also open the print job queue window by double-clicking the machine icon in the [Printers] window, and in Windows XP, the [Printers and Faxes] window.

4 Press the [Printer] key on the machine's control panel.

5 Press [Job Reset] on the display panel.

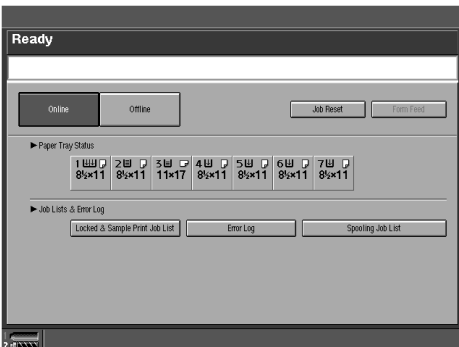

6 Press [Reset Current Job] or [Reset All Jobs].

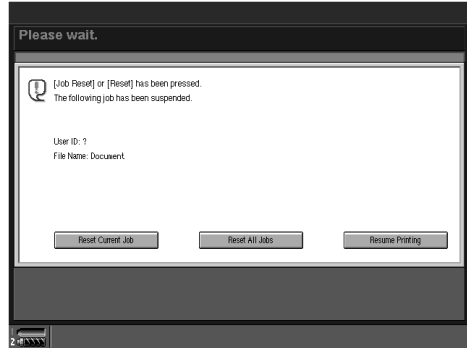

- **[Reset Current Job]**: cancels the print job currently being processed by the machine
- **[Reset All Jobs]**: cancels all jobs in the print queue
- **[Resume Printing]**: resumes printing jobs

A confirmation message appears.

7 Press [Yes] to cancel the print job.

Note

- Press [No] to return to the previous display.
- If the [Resetting Jobs] message does not disappear when you press [Job Reset] when the machine is offline, put the machine online.
- If you press [Job Reset] while the machine is resetting jobs, [Reset Current Job] appears dimmed and cannot be selected. Wait for the jobs to be reset.

Important

- ❑ If the machine is shared by multiple computers, be careful not to accidentally cancel someone else's print job.
- ❑ When the machine is connected to the computer using a parallel cable, sent print jobs may be cancelled if **[Reset All Jobs]** is pressed while the "Waiting..." message is on the display panel. After the interval set in I/O Timeout in Printer Features has passed, the next print job can be sent. A print job sent from a different client computer will not be cancelled in the above case.

Note

- ❑ You cannot stop printing data already processed by the machine. Because of this, printing may continue for a few pages after you press **[Job Reset]**.
- ❑ A print job containing a large volume of data may take considerable time to stop.

Macintosh - Cancelling a Print Job

1 Double-click the printer icon on the desktop.

A window appears, showing all the print jobs that are currently queuing to be printed. Check the current status of the job you want to cancel.

Note

- ❑ In Mac OS X, start Print Center.

2 Select the name of the job you want to cancel.

3 Click the pause icon, and then click the trash icon.

4 Press the **[Printer]** key on the machine's control panel.

5 Press **[Job Reset]** on the display panel.

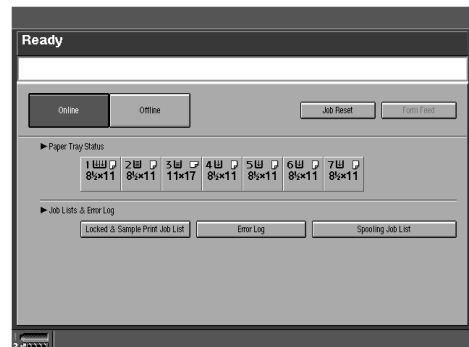

6 Press **[Reset Current Job]** or **[Reset All Jobs]**.

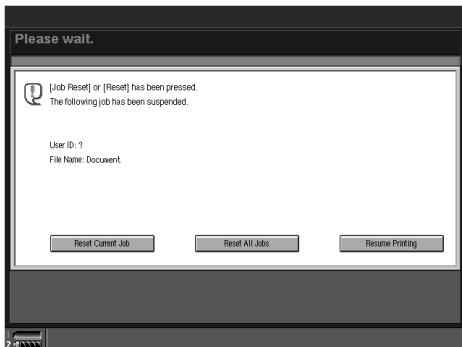

- **[Reset Current Job]**: cancels the print job currently being processed
- **[Reset All Jobs]**: cancels all jobs in the print queue
- **[Resume Printing]**: resumes printing jobs

A confirmation message appears.

7 Press **[Yes]** to cancel the print job.

Note

- Press **[No]** to return to the previous display.
- If the **[Resetting Jobs]** message does not disappear when you press **[Job Reset]** while the machine is offline, put the machine online.
- If you press **[Job Reset]** while the machine is resetting jobs, **[Reset Current Job]** lights dimly and cannot be selected. Wait for the jobs to be reset.

Important

- When the machine is being shared by multiple computers, be careful not to accidentally cancel someone else's print job.
- When the machine is connected to the computer using a parallel cable, sent print job may be cancelled if **[Reset All Jobs]** is cancelled while "Waiting..." is on the display panel. After the interval set in I/O Timeout in Printer Features has passed, the next print job can be sent. A print job sent from a different client computer will not be cancelled in the above case.

Note

- You cannot stop printing data already processed by the machine. Because of this, printing may continue for a few pages after you press **[Job Reset]**.
- A print job containing a large volume of data may take considerable time to stop.

2. Using the Document Server

Accessing the Document Server

The Document Server enables you to store documents on the machine's hard disk to edit and print as you want.

Limitation

- Applications, like PageMaker, which use original drivers do not work with this function.

Reference

For more information about Document Server functions, see *General Settings Guide*.

For information about how to access to Document Server from a client, see the printer driver Help.

Note

- When you use the Document Server, the following functions can be selected using the machine's control panel:
 - Copies
 - Collate
 - Duplex
 - Staple
 - Punch
 - Paper selection: Paper source tray, paper type, paper output tray.
 - Functions related to paper selection: Cover sheets, slip sheets, chaptering.
- The above items are dimmed, so you cannot set them from the **[Printer Properties]** dialog box when the Document Server is selected.
- You must enter a user ID using up to eight alphanumeric characters.
- You should enter Password and File Name to distinguish the job from others.
- Up to 3,000 files can be stored in the Document Server. No new files can be stored once 3,000 files are stored. Even if less than 3,000 files are stored, new files cannot be stored when
 - a file to be stored contains more than 2,000 pages,
 - the total number of pages contained in files stored exceeds 15,000,
 - the hard disk is full.
- The Document Server also stores files that scanned using the Automatic Document Feeder (ADF) or exposure glass. You should delete unnecessary stored files once in a while so as not to exceed the capacity of the hard disk. For how to delete stored files, see *General Settings Guide*.
- When using the hard disk for functions other than Document Server functions, you may be unable to store new files in the Document Server even if there are less than 3,000 files stored.

3. Sample Print/Locked Print

Sample Print

Use this function to print only the first set of a multiple-set print job. After you have checked the result, remaining sets can be printed or cancelled using the machine's control panel. This can help in avoiding large amounts of misprints due to mistakes in the content or in the print settings.

Note

- If the application has a collate option, make sure that it is not selected before sending a print job. By default, sample print jobs are automatically collated by the printer driver. If a collate option is selected from the application print dialog box, more prints than intended may be printed.
- You can identify the file you want to print by the user ID and date and time when the job was stored.
- The number of pages the machine can save depends on the contents of the print image. For example, the machine can save up to 30 jobs, 2,000 pages of one print job or 3,000 pages, including locked print files, depending on data volume.
- If the first set of the sample print files is not as you expected and you do not want to print remaining sets, delete the sample print file using the display panel. If you print the remaining sets of the sample print file, the job in the machine is deleted automatically.
- Turning off the machine's main power switch deletes the locked print file.

Printing a Sample Print File

The following procedure describes how to print a sample print file with the PCL 6/5e printer driver. For information about how to print a sample print file with the PostScript 3 printer driver, see *PostScript 3 Unit Type 2105 Operating Instructions Supplement* included as a PDF file on the CD-ROM.

Limitation

- Applications, like PageMaker, that use their own drivers, do not work with this function.
- If you are using Mac OS X, this function cannot be used.

1 Configure the sample print in the properties of the printer driver.

Reference

For details about configuring the PCL 6/5e or RPCS™ printer driver, see the relevant Help files.

2 Click [OK] in the application's print dialog box to start printing.

Note

- Make sure to set more than two copies.

The sample print job is sent to the machine and the first set is printed.

3 On the machine's control panel, press the **[Printer]** key to display the Printer screen.

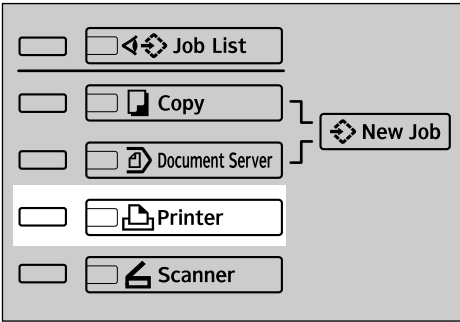

ZJAS1341N

4 Press **[Locked & Sample Print Job List]**.

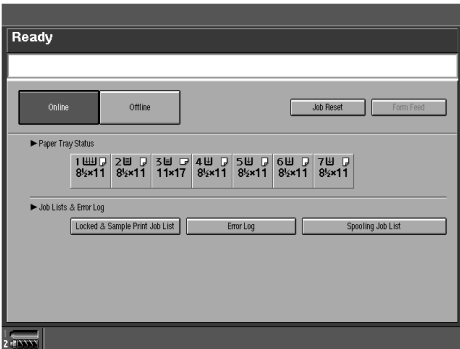

A list of stored sample print jobs and locked print jobs appears.

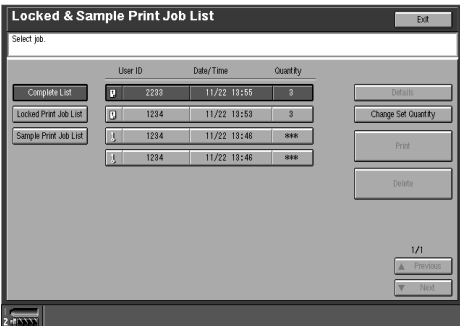

The following will also be displayed:

- User ID: The user ID set up by the printer driver.
- Date/Time : The date and time when the job was sent from the computer.

- Quantity : The number of remaining print sets for sample print jobs (but not locked print jobs) appears.

5 Select the file you want to print by pressing on it.

Normally, the print job at the top of the list is selected.

Note

- ❑ Press **[▲Prev.]** or **[▼Next]** to scroll through the list.
- ❑ Press **[Sample Print Job List]** to display only sample print jobs.
- ❑ Only one file can be selected at a time.
- ❑ Press **[Details]** to display the details of the selected print job, including name and number of pages.

6 Press **[Change Set Quantity]** to change the number of sets to be printed.

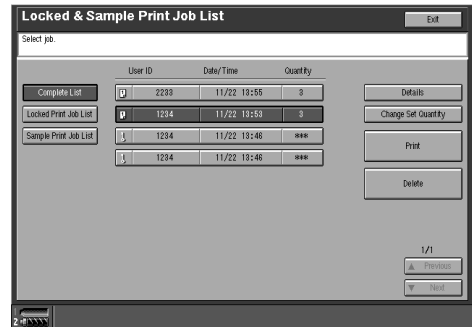

If you do not want to change the set quantity, proceed to step **3**.

- 7** Enter the new number of sets using the number keys, and then press **[OK]**.

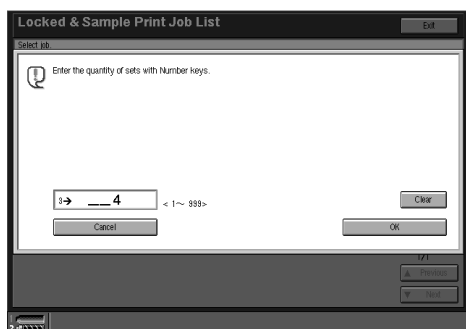

The screen returns to the file list screen.

Note

- You can enter up to 999 sets.
- Press **[Clear]** to correct any entry mistakes.
- If you want to cancel changing the set quantity, press **[Cancel]**.

- 8** Press **[Print]**.

The print confirmation screen is displayed.

- 9** Press **[Yes]**.

The remaining sets are printed.

Note

- Press **[No]** to cancel printing.
- When printing is completed, the stored file will be deleted.
- If printing is stopped by pressing **[Job Reset]** after printing has started, the file will be deleted.
- If there is a print job outstanding, this will be printed before the sample print job.

Deleting a Sample Print File

If you are not satisfied with the sample printout, you can delete the sample print file, revise it and print it again until the settings are suitable.

- 1** Press the **[Printer]** key to display the Printer screen.

- 2** Press **[Locked & Sample Print Job List]**.

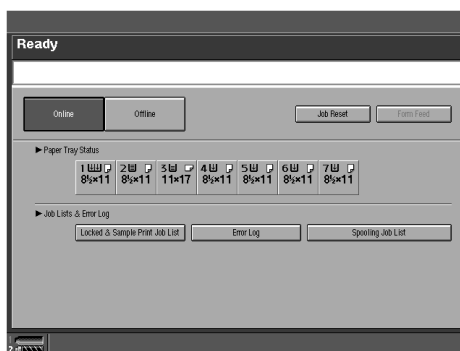

A list of sample print jobs and locked print jobs stored in the machine appears.

- 3** Press the sample print job you want to delete, making it appear highlighted.

Note

- Press **[▲Prev.]** or **[▼Next]** to scroll through the list.
- Press **[Sample Print Job List]** to display only sample print jobs.
- Only one file can be selected at a time.

- 4** Press **[Delete]**.

The delete confirmation screen will be displayed.

- 5** Press **[Yes]** to delete the file.

After the file has been deleted, the screen will return to the file list screen.

Note

- If you do not want to delete the file, press **[No]**.

Locked Print

Use this function to maintain privacy when printing confidential documents on the machine over a shared network. Usually, it is possible to print data using the control panel once the data is stored in this machine. When using Locked Print, it will not be possible to print unless a password is entered on the machine's control panel. Your confidential documents will be safe from viewing by other people.

3

Note

- If the application has a collate option, make sure that it is not selected before sending a print job. Locked print jobs are automatically collated by the printer driver as default. If a collate option is selected from the application print dialog box, more sets than intended may be printed.
- You can identify the file you want to print by User ID and date and time when the job was stored.
- The number of pages the machine can save depends on print image content. For example, the machine can save up to 30 jobs, 2,000 pages of one print job or 3,000 pages including sample print files, depending on data volume.
- After the locked print file is printed, the job is automatically deleted.
- Turning off the machine's main power switch deletes the locked print file.

Printing a Locked Print File

The following procedure describes how to print a locked print file with the PCL 6/5e printer driver. For information about how to print a locked print file with the PostScript 3 printer driver, see *PostScript 3 Unit Type 2105 Operating Instructions Supplement* included as a PDF file on the CD-ROM.

Limitation

- Applications, like PageMaker, that use their own drivers, do not work with this function.
- If you are using Mac OS X, this functions cannot be used.

1 Configure the locked print in the properties of the printer driver.

Reference

For details about configuring the PCL 6/5e or RPCS™ printer driver, see the corresponding Help files.

2 Click [OK] in the application's print dialog box to start printing.

The locked print job is sent to the machine.

3 On the machine's control panel, press the [Printer] key to display the Printer screen.

4 Press [Locked & Sample Print Job List].

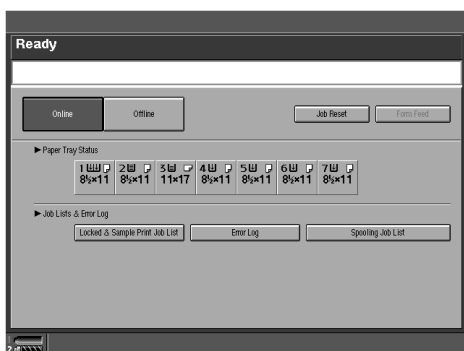

A list of locked print jobs and sample print jobs stored in the machine appears.

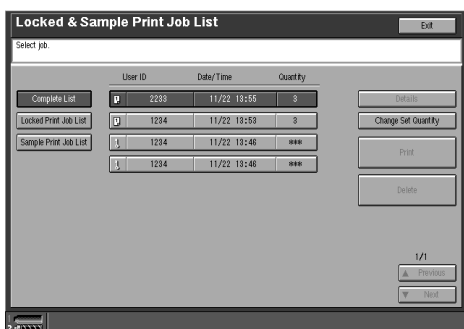

The following will be also be displayed:

- User ID: The user ID set up by the printer driver.
- Date/Time: The date and time when the job was sent from the computer.
- Quantity: The number of remaining print sets appears for sample print jobs but not for locked print jobs.

5 Select the file you want to print by pressing on it.

Note

- ❑ Press [**▲Prev.**] or [**▼Next**] to scroll through the list.
- ❑ Press [**Locked Print Job List**] to display only locked print jobs.
- ❑ Only one file can be selected at a time.
- ❑ Press [**Details**] to display details of the selected print job.

6 Press [Print].

The password screen is displayed.

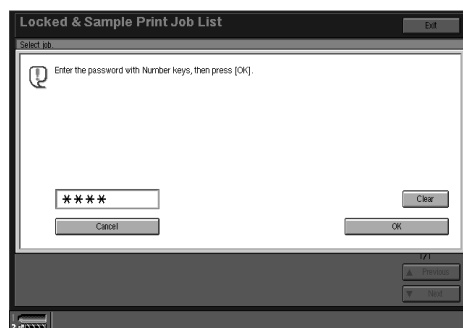

7 Enter the password using the number keys, and then press [OK].

The print confirmation screen is displayed.

Note

- ❑ A confirmation screen will appear if the password is not entered correctly. Press [**OK**] to enter the password again.

8 Press [Yes].

The locked file is printed.

Note

- ❑ Press [**No**] to cancel printing.
- ❑ If printing is stopped by pressing [**Job Reset**] after printing has started, the file will be deleted.

Deleting Locked Print Files

1 Press the **[Printer]** key to display the Printer screen.

2 Press **[Locked & Sample Print Job List]**.

A list of locked print jobs and sample print jobs stored in the machine appears.

3 Select the file you want to delete by pressing on it.

 **Note**

- Press **[▲Prev.]** or **[▼Next]** to scroll through the list.
- Press **[Locked Print Job List]** to display only locked print jobs.
- Only one file can be selected at a time.

4 Press **[Delete]**.

The password screen is displayed.

5 Enter the password using the number keys and press **[OK]**.

The delete confirmation screen is displayed.

6 Press **[Yes]**.

After the file has been deleted, the screen returns to the file list screen.

 **Note**

- If you do not want to delete the file, press **[No]**.

Checking the Error Log

If you cannot store a file in this machine, check the error log on the control panel.

Limitation

- The machine stores a maximum of 90 error log entries: the 20 most recent sample print job errors, the 20a most recent locked print job errors, and the 50 most recent other print job errors.

1 Press the **[Printer]** key to display the Printer screen.

2 Press **[Show Error Log]**.

Error log entries for sample and locked print jobs appear. By pressing **[Sample Print Job List]** or **[Locked Print Job List]**, display can be switched between the entries for each type of print job.

Note

- Press **[▲Prev.]** or **[▼Next]** to scroll through the error files.
- Press **[Exit]** after checking the log.

Displaying Spooled Job List

A list of spooled jobs can be displayed, allowing selected jobs to be deleted.

Note

- The Spooled Job List can also be checked using a Web browser.

3

- 1** Press the **[Printer]** key to display the Printer screen.

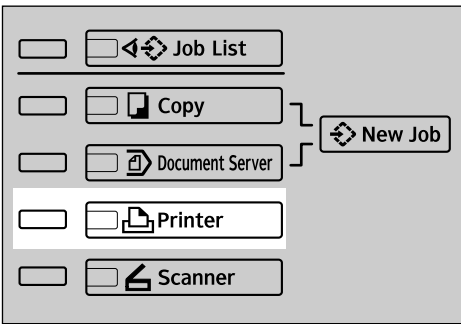

- 2** Press **[Spooling Job List]**.

A list of stored spooled jobs appears.

User Name, File Name, Status, and File Size appear in the list.

The items shown vary according to the protocol in use. For details, see p.53 “Spool Printing”.

Deleting Spooled Print Jobs

Spooled print jobs can be deleted.

- 1** Press the **[Printer]** key to display the Printer screen.

- 2** Press **[Spooling Job List]**.

- 3** Press the job you want to delete, making it appear highlighted.

- 4** Press **[Delete]**.

The deletion confirmation screen is displayed.

- 5** Press **[Yes]**.

The job is deleted.

Note

- If you want to cancel deletion, press **[No]**.

Form Feed

This section gives instructions on operation when the machine does not have a tray for the selected paper size or type, or when paper loaded in the machine has run out.

Limitation

- The tray cannot be changed if the following functions are set for it.
 - Staple
 - Punch
 - Duplex Print to a tray that does not support duplex printing
 - Cover Sheet
 - Front/Back Covers
 - Slip Sheets
 - Chaptering
 - Chapter Slip Sheets

Note

- If form feed is selected for a tray with the following settings, you can change the tray by canceling the settings:
 - Staple
 - Punch
- If Auto Continue is selected, the form feed paper is printed after a set interval. See p.38 "System".

If the machine does not have a tray for the selected paper size or paper type, or if the selected paper loaded in the machine has run out, a caution message appears.

If this message appears, do one of the following.

Print using a selected tray

- 1** Select the tray for form feed from those that appear on the control panel.

If you want to print after adding paper to the tray, select the tray after loading the correct paper.

- 2** Press [OK].

The machine prints using the selected tray.

Note

- If a tray with a small paper size is selected, the print job may be cut short, or other problems may occur.

Canceling the form feed

- 1** Press [Job Reset].

Delete the stored print job, and then cancel form feed.

4. Troubleshooting

Error & Status Messages on the Display Panel

❖ Status messages

Message	Status
Hex Dump Mode	In Hex Dump mode, the machine receives data in hexadecimal format. Turn off the machine after printing, and then turn back on.
Offline	The machine is offline. Set the machine online by pressing [Online] on the display panel to start printing.
Please Wait	The machine is readying the development unit. Wait for a while.
Printing...	The machine is printing. Wait for a while.
Ready	The default ready message. The machine is ready for use. No action is required.
Resetting Job(s)...	The machine is resetting the print job. Wait until "Ready" appears on the display panel.
Waiting...	The machine is waiting for the next data to print. Wait for a while.

❖ Alert messages

Messages/Second messages	Description	Solution
Ethernet board has a problem.	An error has occurred in the Ethernet board.	Turn off the main power switch, and on. If the message appears again, contact your sales or service representative.
NV-RAM has a problem.	An error has occurred in the optional memory unit.	Turn off the main power switch, and on. If the message appears again, call your sales or service representative.
Paper is left in the Finisher. Open Finisher Front Cover and remove the paper.	There is paper remaining inside the finisher.	Open the cover of finisher, and remove the paper.
Parallel I/F board has a problem.	An error has occurred in the parallel interface board.	Contact your sales or service representative.
The selected paper tray is in use by another function. Please wait.	The specified paper tray is in use by another function such as copier function.	Wait until the other function has finished using the specified paper tray.
Staple unit is in use by another function. Please wait.	The staple unit is in use by another function such as copier function.	Wait until the other function has finished using the staple unit.

The Machine Does Not Print

4

Possible Cause	Solutions
Is the power on?	Confirm the cable is securely plugged into the power outlet and the machine. Turn on the main power switch.
Is the machine online?	If not, press [Online] on the display panel.
Does the printer function status indicator stay red?	If so, check the error message on the display panel and take required action.
Is there a warning status or error message on the display panel?	If so, check the error message or warning status on the display panel and take the required action.
Can you print a configuration page?	If you cannot print a configuration page, there maybe a machine malfunction. Contact your sales or service representative. See p.34 "Printing the Configuration Page" for printing a configuration page.
Is the interface cable connected securely to the machine and computer?	Connect the interface cable securely. If it has a fastener, fasten it securely as well. See "Connecting the Machine", <i>Printer Reference 1</i> .
Are you using the correct interface cable?	The type of interface cable you should use depends on the computer. Be sure to use the correct one. If the cable is damaged or worn, replace it. See "Connecting the Machine", <i>Printer Reference 1</i> .
Was the interface cable connected after the machine was turned on?	Connect the interface cable before turning on the machine.
Is the signal status satisfactory when using wireless LAN in Infrastructure mode ?	To check signal status, press [User Tools] on the display panel, and then press [System Settings] on the display panel. On the [Interface Settings] tab, select [IEEE 802.11b] , and then press [Wireless LAN Signal] . If signal quality is bad, move the machine to a location where signals can pass or remove objects that might block signals.  Note <input type="checkbox"/> You can check signal status only when using a wireless LAN in Infrastructure mode.
When using wireless LAN, is the SSID correctly set?	Confirm on the machine's display panel that the SSID is correctly set. See "Interface Settings/IEEE 802.11b (Option)", <i>General Settings Guide</i> .

Possible Cause	Solutions
When using wireless LAN, is the access point correctly set?	<p>Confirm access point settings when in Infrastructure mode. Depending on the access point, client access may be limited by the MAC address.</p> <p>Also, confirm there are no problems in transmission between access point and wired clients, and between access point and wireless clients.</p>
When using wireless LAN, is the LED on the wireless LAN card lit or blinking?	<p>Confirm the orange LED is lit, and the green LED is lit or blinks during transmission.</p>
Is the wireless LAN being used in Ad Hoc mode?	<p>If so, turn the main power switch off and on. Also, changing some of the settings in [Network] on the [Interface Settings] tab in [System Settings] on the display panel may solve the problem.</p>
Did you change the option settings on the machine?	<p>When using the RPCS™ printer driver on Windows 2000 and connecting with IEEE 1394, an error may occur if you change the option settings on the machine. In this case, follow the procedure below:</p> <ol style="list-style-type: none"> ① Unplug the IEEE 1394 interface cables connected to the computer. ② Run the utility tool for the IEEE 1394 interface board, which is stored in the following path on the CD-ROM labeled "Printer Drivers and Utilities". <code>\UTILITY\1394\</code> <p> Reference For more information about using the utility tool for IEEE 1394, see the README file in the same directory on the CD-ROM.</p> ③ Restart the computer. ④ Connect the computer to the machine using the IEEE 1394 interface cables.
Is the weekly timer set?	<p>The printer may not be able to print because of the weekly timer setting. Check the setting. For details, see "User Tools (System Settings)", <i>General Settings Guide</i>.</p>



Problem	Solutions
<p>Is the Data In indicator blinking or lit after starting the print job?</p>	<p>If not, data is not being sent to the machine.</p> <ul style="list-style-type: none"> ❖ When the machine is connected to the computer using the interface cable <p>Confirm that machine port settings are correct. For a parallel port connection, port LPT1 or LPT2 should be set.</p> <ul style="list-style-type: none"> • Windows 95/98/Me <ol style="list-style-type: none"> ① Click the [Start] button, point to [Settings], and then click [Printers]. ② Click the icon of the machine. On the [File] menu, click [Properties]. ③ Click the [Details] tab. ④ Check the [Print to the following port] box to confirm that the correct port is selected. • Windows 2000 <ol style="list-style-type: none"> ① Click the [Start] button, point to [Settings], and then click [Printers]. ② Click the icon of the machine. On the [File] menu, click [Properties]. ③ Click the [Port] tab. ④ Check the [Print to the following port] box to confirm that the correct port is selected. • Windows XP Professional <ol style="list-style-type: none"> ① Click the [Start] button, and then click [Printers and Faxes]. ② Click the icon of the machine. On the [File] menu, click [Properties]. ③ Click the [Ports] tab. ④ Check the [Point to the following port(s)] box to confirm that the correct port is selected. • Windows XP Home Edition <ol style="list-style-type: none"> ① Click the [Start] button, [Control Panel], [Printers and Other Hardware], and then [Printers and Faxes]. ② Click the icon of the machine. On the [File] menu, click [Properties]. ③ Click the [Ports] tab. ④ Check the [Point to the following port(s)] box to confirm that the correct port is selected. • Windows NT 4.0 <ol style="list-style-type: none"> ① Click the [Start] button, point to [Settings], and then click [Printers]. ② Click the icon of the machine. On the [File] menu, click [Properties]. ③ Click the [Port] tab. ④ Check the [Print to the following port] box to confirm that the correct port is selected. ❖ Network connection <p>Contact your network administrator.</p>

Other Printing Problems

Problem	Causes, Descriptions, and Solutions
The print on the entire page is faded.	<p>If Toner Saver is selected in the [Print Quality] tab on the printer driver tab, the entire page will be faded when printed.</p> <p>See the printer driver Help.</p>
The print smudges.	<p>Settings for thick paper have not been made when printing on thick paper.</p> <ul style="list-style-type: none"> • PCL 6/5e and PostScript 3 Select [Thick] for [Type] on the printer driver [Paper] tab. • RPCS™ Select [Thick] for [Paper Type] on the printer driver [Print Settings] tab.
When printing graphics, the output and the screen are different.	<p>If the printer driver is configured to use the graphics command, the graphics command from the machine is used to print.</p> <p>If you want to print accurately, set the printer driver to print without using the graphics command.</p> <p>See the printer driver Help.</p>
Page layout is not as expected.	<p>Print areas differ depending on machine used. Information that fits on a single page on one machine may not fit on a single page of another machine.</p> <p>Adjust the [Printable area] setting in the [Printer Configuration] dialog box on the [Print Settings] tab in the RPCS™ printer driver.</p> <p>See the printer driver Help.</p>
Duplex printing is malfunctioning.	<ul style="list-style-type: none"> • Duplex printing cannot be done with thick paper, OHP transparencies, translucent, tab stock or labels specified as the paper type. Specify another paper type. • Duplex printing cannot be done with a tray for which [1-Sided Copy] has been specified as Paper Type on the System Settings menu. Change the Paper Type setting for the tray to [2-Sided Copy] on the System Settings menu. See <i>General Settings Guide</i>.
When using Windows 95/98/Me, Windows2000/XP, or Windows NT4.0, either combined printing or booklet print does not come out as expected.	<p>Make sure the application's paper size and orientation settings match those of the printer driver.</p> <p>If a different paper size and orientation are set, select the same size and orientation.</p>
When using Windows 95/98/Me, Windows2000/XP, or Windows NT4.0, Auto Reduce/Enlarge print does not come out as expected.	

Problem	Causes, Descriptions, and Solutions
A print instruction was issued from the computer, but printing did not start.	User code management may have been set. Ask the administrator about valid user codes. To print, the user code must be entered from the printer driver.
The print job is not cancelled even when the machine is switched to offline status.	Even when the machine is offline, printing is performed when [Job Receive] has been set in Signal Control in the System Settings menu. Change the system setting of Signal Control to Printer priority. See “User Tools (System Settings)”, <i>General Settings Guide</i> .
Photo images are coarse.	Some applications lower print resolution.
Fine dot pattern does not print.	Make the following settings with the printer driver: <ul style="list-style-type: none"> • Change the [Dithering] setting on the [Image Adjustments] tab in the [Change User Settings] dialog box on the [Print Quality] tab in the RPCS™ printer driver's dialog box. See the printer driver Help.
Images are cut off, or excess is printed.	You may be using paper smaller than the size selected in the application. Use the same size paper as that selected in the application. If you cannot load paper of the correct size, use the reduction function to reduce the image, and then print. See the printer driver Help.
It takes too much time to complete a print job.	Photographs and other data intensive pages take a long time for the machine to process, so simply wait when printing such data. Changing the following settings with the printer driver may help to speed up printing: <ul style="list-style-type: none"> • PCL 6/5e Select the lowest value for [Resolution] on the [Print Quality] tab in the printer driver's dialog box. • PostScript 3 Select the lowest value for [Gradation] on the [Print Quality] tab in the printer driver's dialog box. Select [PostScript (optimize for speed)] for PostScript output format on the [PostScript] tab in the printer driver's dialog box. • RPCS™ Select the lowest value for [Resolution] on the [Image Adjustments] tab in the [Change User Settings] dialog box on the [Print Quality] tab in the printer driver's dialog box. Select [Speed] for [Print priority] on the [Print Quality] tab in the printer driver's dialog box. See the printer driver Help.
	The data is so large or complex that it takes time to process. If the Data In indicator is blinking, data is being processed. Just wait until printing resumes.
	If “Warming Up...” appears on the display panel, the machine is warming up. Wait for a while.

Problem	Causes, Descriptions, and Solutions
It takes too much time to resume printing.	The data is so large or complex that it takes time to process. If the Data In indicator is blinking, data is being processed. Just wait until printing resumes.
	The machine was in Energy Saver mode. To resume from Energy Saver mode, it has to warm up, and this takes time. To disable Energy Saver mode, select [Off] for Energy Saver 1 in the System Settings menu. See <i>General Settings Guide</i> .
Paper is not fed from the selected tray.	When you are using a Windows operating system, printer driver settings override those set using the display panel. Set the desired input tray using the printer driver. See the printer driver Help.
Solid lines are printed as broken lines.	Make the following settings with the printer driver: <ul style="list-style-type: none"> • Change the [Dithering] setting under the [Image Adjustments] tab in the [Change User Settings] dialog box, under the [Print Quality] tab in the RPCS™ printer driver's dialog box. See the printer driver Help.
Optional components connected to the machine are not recognized when using Windows 95/98/Me, Windows 2000/XP, and Windows NT 4.0.	You have to configure the option setup in printer properties when bidirectional transmission is not enabled. See the printer driver Help.
Images are printed in the wrong orientation.	The feed orientation you selected and the feed orientation selected in the printer driver's option setup might not be the same. Set the machine's feed orientation and the printer driver's feed orientation accordingly. See the printer driver Help.
The printed image is different from the image on the computer's display.	With certain functions, such as enlargement and reduction, the layout of the image might be different to that on the computer display.
	You might have selected to replace True Type fonts with machine fonts in the printing process. To print an image similar to the image on the computer display, make settings to print True Type fonts as an image. See the printer driver Help.

Problem	Causes, Descriptions, and Solutions
<p>No transmission when you use IEEE 1394 interface connection</p>	<p>Check using the following procedure:</p> <ol style="list-style-type: none"> ① Confirm the IEEE 1394 interface cable is connected securely. ② Restart the computer. If the error occurs even after executing the above operation, proceed to the following steps. ③ Unplug the IEEE 1394 interface cable connected to the computer. ④ Run the utility tool for the IEEE 1394 interface board, which is stored in the following path on the CD-ROM labeled "Printer Drivers and Utilities": <code>\UTILITY\1394\</code> <p> Reference For more information about using the utility tool for IEEE 1394, see the README file in the same directory on the CD-ROM.</p> <ol style="list-style-type: none"> ⑤ Restart the computer.
<p>Printing stops and a paper error is displayed if the custom size paper in the paper feed tray is specified when printing with the PostScript 3 printer driver.</p>	<p>Follow the one of the procedures below:</p> <ul style="list-style-type: none"> • Press [Job Reset] on the display panel to stop printing. Place the custom size paper in the Multi Bypass Tray (Tray7), and then start printing. • Select the paper feed tray with custom size paper, and then press [Continue] to force printing.
<p>When connecting the machine using the USB 2.0 interface, the first page of a print job that contains a large volume of data is printed, and the rest of the pages are not printed.</p>	<p>Confirm that USB Printing Support is installed on your computer.</p> <p> Reference See "Installing the Printer Driver Using USB", <i>Printer Reference 1</i>.</p>

 **Note**

- If the problem cannot be solved, contact your sales or service representative.

5. Printer Features

Although the factory default are suitable for most printing jobs, the Printer Features gives you access to a number of settings that control basic printer operations. The Printer Features settings you make are retained even when you turn off the machine.

Reference

For more information about copier features and system settings, see *Copy Reference* and *General Settings Guide*.

Printer Features Menu

There are six menu items in the Printer Features menu:

- List/Test Print
- Maintenance
- System
- Host Interface
- PCL Menu
- PS Menu

You can select functions in the following table:

Category	Function menu
List/Test Print See p.34 "List/Test Print".	Multiple Lists
	Configuration Page
	Error Log
	Menu List
	PCL Configuration/Font List
	PS Configuration/Font List (optional)
	Hex Dump
Maintenance See p.37 "Maintenance".	Menu Protect

Category	Function menu
System See p.38 "System".	Print Error Report
	Auto Continue
	Memory Overflow
	Job Separation
	Memory Usage
	Duplex
	Copies
	Edge Smoothing
	Spool Image
	Toner Saving
	Reserved Job Waiting Time
	Sub Paper Size
	Page Size
	Letterhead Setting
Edge to Edge Print	
Host Interface See p.41 "Host Interface".	I/O Buffer
	I/O Timeout
PCL Menu See p.41 "PCL Menu".	Orientation
	Form Lines
	Font Source
	Font Number
	Point Size
	Font Pitch
	Courier Font
	Symbol Set
	Extend A4 Width
	Append CR to LF
	Resolution
PS Menu (optional) See p.43 "PS Menu".	Data Format
	Resolution

Adjusting Printer Features

Printer Features allow basic adjustment of operations when the machine is used as a printer.

Although the factory default are suitable for most printing jobs, the Printer Features gives you access to a number of settings that control basic printer operations. The Printer Features settings you make are retained even when you turn off the machine.

For more information about copier features and system settings, see *Copy Reference* and *General Settings Guide*.

1 Press the **[User Tools]** key on the control panel.

2 Press **[Printer Features]**.

3 Select the desired item by pressing the tab, and then change the settings.

 **Note**

- [OK]**: Press to set the new settings and return to the previous menu.
- [Cancel]**: Press to return to the previous menu without changing any setting.

4 After changing Printer Features settings, press **[Exit]** to return to the User Tools menu.

 **Note**

- You can also exit from the User Tools menu by pressing the **[User Tools]** key.
- Changes made to functions remain in effect even if the machine is turned off.
- You can also exit from the Printer Features menu by pressing **[Exit]** in the main menu.

Printer Features Parameters

List/Test Print

❖ Multiple Lists

Prints the configuration page and error log.

❖ Configuration Page

You can print the current configuration of the machine.

🔍 Reference

See p.34 “Printing the Configuration Page” to print a configuration page.

❖ Error Log

Prints a list of the stored error logs.

❖ Menu List

You can print a Menu List that shows the machine's function menus.

❖ PCL Configuration/Font List

You can print the current configuration of installed PCL fonts.

❖ PS Configuration/Font List

You can print the current configuration of installed PostScript fonts.

📌 Note

- This menu can be selected only when the optional PostScript 3 board is installed.

❖ Hex Dump

You can print the Hex Dump.

Printing the Configuration Page

1 Press the **[User Tools]** key on the control panel.

The User Tools menu appears.

2 Press **[Printer Features]**.

The Printer Features menu appears.



3 Press **[Configuration Page]** on the **[List/Test Print]** tab.

The configuration page is printed.

Interpreting the Configuration Page

System Reference

❖ Unit Number

Shows the serial number assigned to the board by its manufacturer.

❖ Total Memory

Shows the total amount of memory (SDRAM) installed on the printer.

❖ Firmware Version

- Firmware
Shows the version number of the printer firmware.
- System
Shows the version number of system.
- Engine
Shows the version number of the printer engine.
- Panel
Shows the version number of panel display.
- NIB
Shows the version number of the Network interface.

❖ Controller Option

The item(s) appears when the controller option(s) is installed.

❖ HDD: Font/ Macro Download

Shows the capacity of HDD.

❖ Printer Language

Shows the version number of the printer driver language.

❖ Options

Shows the optional trays that you installed.

Paper Input

Shows the settings made under the **【Tray Paper Settings】** key.

Reference

For more information, see *General Settings Guide*.

System

Shows the settings made under the “System” menu.

 **Reference**

For more information, see p.38 “System”.

PCL Menu

Shows the settings made under the “PCL Menu”.

 **Reference**

For more information, see p.41 “PCL Menu”.

Host Interface

Shows the settings made under the “Host Interface” menu.

When DHCP is active on the network, the actual IP Address, Subnet Mask and Gateway Address appear in parentheses on the configuration page.

 **Reference**

For more information about “Host Interface” menu, see p.41 “Host Interface”.

Interface Information

Shows the interface information.

Maintenance

❖ Menu Protect

This procedure lets you protect menu settings from accidental changes. It makes it impossible to change menu settings with normal procedures unless you perform the required key operations. In a network environment, only administrators can make changes to menu settings.

- Level 1
You can protect the “Maintenance”, “System”, “Host Interface”, “PCL Menu” and “PS Menu”.
- Level 2
You can protect the Multiple List and Error Log in “List/Test Print”, “Maintenance”, “System”, “Host Interface”, “PCL Menu” and “PS Menu”.
- Off

Note

- Default: Off
- You can protect menu settings using Web browser.

Setting Menu Protect

- 1** Press the **[User Tools]** key on the control panel.
The User Tools menu appears.
- 2** Press **[Printer Features]**.
The Printer Features menu appears.
- 3** Press **[Maintenance]**.
- 4** Press **[Menu Protect]**.

5 Enter an access code using the number keys, and then press **[OK]**.

6 Select a menu protect level, and then press **[OK]**.

7 Press **[Exit]**.

The User Tools menu appears.

8 Press **[Exit]**.

Note

- You can also exit the User Tools menu by pressing the **[User Tools]** key.

Canceling Menu Protect

1 Press the **[User Tools]** key on the control panel.

2 Press **[Printer Features]**.

3 Press **[Maintenance]**.

A screen for entering the access codes appears.

4 Enter an access code using the number keys, and then press **[OK]**.

5 Press **[Menu Protect]**.

6 Select **[Off]**, and then press **[OK]**.

7 Press **[Exit]**.

The User Tools menu appears.

8 Press **[Exit]**.

Note

- You can also exit the User Tools menu by pressing the **[User Tools]** key.

Temporarily canceling Menu Protect

When you select the protected items in Printer Features, a screen for entering the access codes appears. When this happens, enter the correct access codes using the number keys, and then press **[OK]**. Menu Protect is canceled temporarily.

Note

- If you enter the correct access codes, Menu Protect stays canceled while the Printer Features menu appears.

System

❖ Print Error Report

You can select this to have an error report printed when a printer error or memory error occurs.

- Off
- On

Note

- Default: Off

❖ Auto Continue

You can select this to enable Auto Continue. When it is On, printing continues after a system error occurs.

- Off
- Immediate
- 1 minute
- 5 minutes
- 10 minutes
- 15 minutes

Note

- Default: Off

❖ Memory Overflow

You can select this to have the memory overflow error report printed.

- Not Print
- Error Report

Note

- Default: Not Print

❖ Job Separation

You can enable Job Separation.

- On
- Off

Note

- Default: Off
- This menu appears only when the optional finisher is installed.

❖ Memory Usage

You can select the amount of memory used in Font Priority or Frame Priority, according to paper size or resolution.

- Font Priority
This setting uses memory for registering fonts.
- Frame Priority
This setting uses frame memory for high speed printing.

Note

- Default: Frame Priority

❖ Duplex

You can select to have print on both sides of each page.

- Off
- Short Edge Bind
- Long Edge Bind

Note

- Default: Off

❖ Copies

You can set the number of sets of prints. This setting is disabled if the number of pages to print has been specified with the printer driver or a command.

- 1 to 999 by 1

Note

- Default: 1

❖ Edge Smoothing

You can set this to enable Edge Smoothing.

- On
- Off

Note

- Default: On
- If Toner Saving is set to On, Edge Smoothing is ignored even if it is set to On.

❖ Spool Image

You can select to print spool images.

The print job transmitted from the computer is temporarily stored on the machine's hard disk as bitmap images that can be printed when transmission is complete.

If more than one print job is transmitted, a spool image is printed for each.

- On
- Off

Note

- Default: Off

Important

- When printing spool images, the hard disk is active and the Data-In indicator will blink. Turning off the computer or machine while printing spool images the hard disk. Do not turn off the computer or machine while printing spool images.

❖ Toner Saving

You can this to enable Toner Saving.

- On
- Off

Note

- Default: Off

❖ Reserved Job Waiting Time

Sets Reserved Job Waiting Time.

- Long Wait
- Medium Wait
- Short Wait
- In Reserved Job Order

Note

- Reserved Job Waiting Time is available only when **[Job Order]** is selected for **[Print Priority]** in System Settings. For details about the Print Priority settings, see *General Settings Guide*.

❖ Sub Paper Size

You can enable the Auto Substitute Paper Size (A4↔LT) feature.

- Auto
- Off

Note

- Default: Off

❖ Paper Size

You can select the default paper size.

- 11 × 17
- 12 × 18
- 8½ × 14
- 8½ × 11
- 5½ × 8½
- 7¹/₄ × 10½
- 8 × 13
- 8½ × 13
- 8¹/₄ × 13
- A3
- B4 JIS
- A4
- B5 JIS
- A5
- A6
- Custom Size

Note

- Default:
 - Metric version: A4
 - Inch version: 8½ × 11

❖ Letterhead Setting

You can select whether or not to rotate original images when printing.

When printing, original images are always rotated by 180 degrees. Therefore, output might not be as expected when printing onto a letterhead or preprinted paper requiring orientation. Using this function, you can specify image rotation.

- Off
- Auto Detect
- On (Always)

Note

- Default: Off
- When set to Off, original images are rotated by 180 degrees.
- When set to Auto Detect, the machine detects a letterhead or preprinted paper automatically, and does not rotate original images.
- When set to On (Always), the machine does not rotate original images.
- This function reduces the printing speed.

❖ Edge to Edge Print

You can select whether or not to print on the entire sheet.

- On
- Off

Note

- Default: Off
- The 5 mm margin along the edges may not be printed properly.

Host Interface

❖ I/O Buffer

You can set the size of the I/O Buffer. Normally it is not necessary to change this setting.

- 128 KB
- 256 KB
- 1 MB

Note

Default: 128 KB

❖ I/O Timeout

You can set how many seconds the machine should wait before ending a print job. If data from another port usually arrives in the middle of a print job, you should increase the timeout period.

- 10 seconds
- 15 seconds
- 20 seconds
- 25 seconds
- 60 seconds

Note

Default: 15 seconds

PCL Menu

❖ Orientation

You can set the page orientation.

- Portrait
- Landscape

Note

Default: Portrait

❖ Form Lines

You can set the number of lines per page.

- 5 to 128 by 1

Note

Default:

- Metric version: 64
- Inch version: 60

❖ Font Source

You can set the location of the default font.

- Resident
- RAM
- HDD

Note

Default: Resident

RAM and HDD can be selected only when fonts have been downloaded to the machine.

❖ Font Number

You can set the ID of the default font you want to use.

- 0 to 50 by 1

Note

Default: 0

❖ **Point Size**

You can set the point size you want to use for the selected font.

- 4.00 to 999.75 by 0.25

 **Note**

- Default: 12.00
- This setting is effective only for a proportional-spaced font.

❖ **Font Pitch**

You can set the number of characters per inch for the selected font.

- 0.44 to 99.99 by 0.01

 **Note**

- Default: 10.00
- This setting is effective only for a fixed-spaced font.

❖ **Symbol Set**

You can specify the set of print characters for the selected font. The available options are as follows:

Roman-8, ISO L1, ISO L2, ISO L5, PC-8, PC-8 D/N, PC-850, PC-852, PC8-TK, Win L1, Win L2, Win L5, Desktop, PS Text, VN Intl, VN US, MS Publ, Math-8, PS Math, VN Math, Pifont, Legal, ISO 4, ISO 6, ISO 11, ISO 15, ISO 17, ISO 21, ISO 60, ISO 69, Win 3.0

 **Note**

- Default: Roman-8

❖ **Courier Font**

You can select a courier font type.

- Regular
- Dark

 **Note**

- Default: Regular

❖ **Extend A4 Width**

You can extend the printing area width, when printing on A4 sheet with PCL.

- Off
- On

 **Note**

- Default: Off
- When the setting is On, the width will be 8½ inches.

❖ **Append CR to LF**

When set to On, a carriage return will be appended to each line feed: CR=CR, LF=CR-LF, FF=CR-FF.

- Off
- On

 **Note**

- Default: Off

❖ **Resolution**

You can set the print resolution in dots per inch.

- 300 dpi
- 600 dpi

 **Note**

- Default: 600 dpi

PS Menu

❖ Data Format

You can select a data format.

- Binary Data
- TBCP



Limitation

- This setting is not effective when operating the machine with a parallel, USB or Ether-Talk connection.
- When operating the machine with a parallel or USB connection, if Pure binary data is sent from the printer driver, the print job is canceled.
- When operating the machine with an Ethernet connection, the print job is canceled under the following conditions;
 - The printer driver data format is TBCP and the data format selected on the control panel is Binary Data.
 - The printer driver data format is Pure binary data and the data format selected on the control panel is TBCP.



Note

- Default: Binary Data

❖ Resolution

You can set the print resolution in dots per inch.

- 300 dpi
- 600 dpi
- 1200 dpi



Note

- Default: 600 dpi

Finisher

You can collate, staple or punch holes in printed paper by installing the optional finisher on this machine. Make sure to read the following precautions when using the optional finisher:

Reference

For information about optional finishers, see *General Settings Guide*.

To use the staple function, see p.46 “Staple”.

To use the punch function, see p.49 “Punch”.

❖ **Make sure to set the options installed on the machine in the printer drivers.**

Reference

To set options in the printer drivers, see *Printer Reference 1*.

❖ **Make sure to set the paper size and paper orientation in the printer driver when using duplex printing, combine (layout), staple and punch functions.**

Reference

For Information about duplex printing, booklet, and layout, see the printer driver Help.

To use the staple function, see p.46 “Staple” and the printer driver Help.

To use the punch function, see p.49 “Punch” and the printer driver Help.

Note

- Depending on the application, print settings may not be enabled and printed output may not be as expected.

Staple

With the optional finisher installed, sets can be stapled individually when printing multiple sets.























Staple Position

The specified staple position varies depending on paper size, type, quantity and feed orientation. The following table shows staple positions:

Paper Orientation on the Machine	Print Data Direction	Staple Position	Finisher 3000B	Booklet Finisher
	R Vertical	Top Left Slant	R	R
		Top Right Slant	X	X
		Top Left	R	R
		Top Right	R	R
		2 at Top	X	X
		2 at Left	R	R
		2 at Right	R	R
		2 at Center	X	X
	R Horizontal	Top Left Slant	X	X
		Top Right Slant	R	R
		Top Left	R	R
		Top Right	R	R
		2 at Top	R	R
		2 at Left	X	X
		2 at Right	X	X
		2 at Center	X	X

X : means that the staple position is not supported.

BELSTPL2E

Paper Orientation on the Machine	Print Data Direction	Staple Position	Finisher 3000B	Booklet Finisher
	Vertical 	Top Left Slant	×	×
		Top Right Slant		
		Top Left		
		Top Right		
		2 at Top		
		2 at Left	×	×
		2 at Right	×	×
		2 at Center	×	
	Horizontal 	Top Left Slant		
		Top Right Slant	×	×
		Top Left		
		Top Right		
		2 at Top	×	×
		2 at Left		
		2 at Right		
		2 at Center	×	

× : means that the staple position is not supported.

BELSTPL3E

Reference

- For paper sizes and maximum numbers of sheets available for stapling, see “Specification”, *General Settings Guide*.
- For printing method, see the printer driver Help.
- The stapling position will vary when using the PostScript 3 printer driver. For more information, see the PostScript 3 printer driver Help.

Precaution on stapling

Limitation

- Stapling can be done only with the optional finisher installed.
- You cannot interrupt the current job with a job for another function requiring stapling or collating.

Note

















- When the finisher is installed, and when an output tray that cannot output using the staple function has been selected, the paper will be output according to System Settings.
- If you cannot make staple settings even with the finisher installed, options may not be set correctly in the printer driver. Correct option settings in the printer driver. For details, see the printer driver Help.
- When duplex printing is selected, adjust staple positions to the binding direction.
- If **[2 at Center]** is selected for the staple position when the booklet function is being used, the desired booklet results may not be achieved depending on the operating system and application used.
- When the finisher is being used for another function's job (for example, a copy job), printing will start after that job ends.
- When setting Staple in the printer driver settings, make sure that a collate option is not selected in the print settings of the application. If a collate option is selected in the application, printing will not occur as intended.
- Be sure to set paper size and orientation in the printer driver when stapling.
 - Depending on the software you are using, print settings may not be saved and the printed result may not be as expected.
- Staple printing will be cancelled under the following conditions:
 - If the number of staple jobs exceeds maximum. For information about the maximum number, see "Specification", *General Settings Guide*.
 - If a paper size that cannot be stapled is selected. For information about paper sizes that can be stapled, see "Specification", *General Settings Guide*.
 - If a paper type that cannot be stapled is selected. Labels, OHP transparencies and translucent cannot be stapled.
 - If positions other than those fixed for stapling are specified.
 - If there are inconsistencies between the duplex folding direction and the staple position during duplex printing.
 - If paper sizes are mixed when a different paper size is specified during a print job.
 - When staples have run out.
 - When staples have run out and when Auto Continue has been set, printing will continue without stapling after the message has been displayed.

Punch

With the optional finisher installed, holes can be punched into printed output.

Punch Position

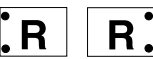
The specified punch position varies depending on the paper feed orientation and print data orientation. The following table shows punch positions:

Paper Orientation on the Machine	Print Data Direction	Punch Position		
		2 holes	3 holes	4 holes
	 Vertical			
	 Horizontal			
	 Vertical			
	 Horizontal			

GPSTPL5E

Note

- Hole positions will vary slightly from page to page as holes punched on each page.

Reference

For information about paper sizes that can be punched, see “Specification”, *General Settings Guide*.

For printing methods, see the printer driver Help.

The punch position will vary when using the PostScript 3 printer driver. For details, see the PostScript 3 printer driver Help.

Precautions when punching

Note

- If you cannot make punch settings even with the finisher installed, options may not be set correctly in the printer driver. Correct option settings in the printer driver. For details, see the printer driver Help.
- When duplex printing is selected, adjust punch positions to the binding orientation.
- Be sure to set the punch position same as the staple position when using it together with the staple function.
- Be sure to set paper size and orientation in the printer driver when punching.
 - Depending on the software you are using, print settings may not be enabled and the printed result may not be as expected.
- Punch will be cancelled under the following conditions:
 - When a paper size that cannot be punched is selected. For information about paper sizes that can be punched, see “Specification”, *General Settings Guide*.
 - When a paper type that cannot be punched is selected. Labels, Thick paper, Translucent and OHP transparencies cannot be punched.
 - If positions other than those fixed for punching are specified.
 - If there are inconsistencies between the duplex folding section and the punch position during duplex printing.
 - When the punch receptacle has become full and when Auto Continue has been set, printing will continue without punching after the message has been displayed.

Collate

When printing multiple documents such as materials for meetings, you can separate sets into order. This function is known as “Collate”. Collate stores data transmitted from a computer into the machine's memory. The following are the three types of collate:

❖ Collate

Printed output is assembled as sets in sequential order.

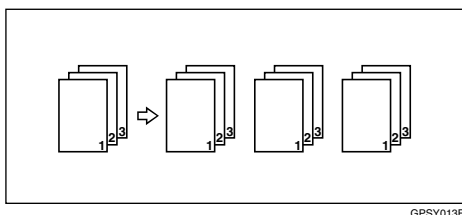

GPSY013E

❖ Rotating Collate

Every other print set is rotated by 90 degrees .

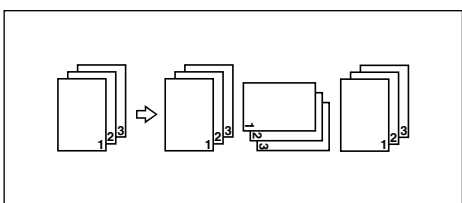

GPSY014E

❖ Shift Collate

The optional finisher is required for this function.

The finisher shift tray moves backward or forward a job or set is output, causing the next to shift so you can separate each set or job.

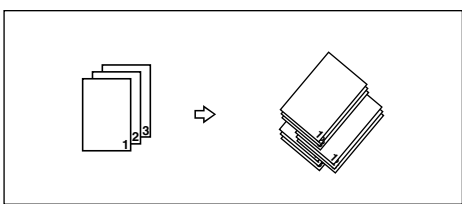

GPSY015E

! Limitation

- The optional finisher is required for Shift Collate.
- Shift Collate is not possible when printing on $8\frac{1}{2}'' \times 5\frac{1}{2}''$ .
- When jobs containing pages of various sizes have been set, Rotating Collate will not work.
- Rotating Collate, staple and punch functions cannot be combined.

 **Note**

- You can set collate or rotate in the RPCS™ printer driver.
 - If you cannot make Shift Collate even with the optional finisher installed, options may not be set up correctly in the printer driver. Correct option settings in the printer driver. For details, see the printer driver Help.
- If Auto Continue occurs on the first set, Collate will be cancelled.
- If forced printing occurs on the first set, Collate will be cancelled.
- If a document with mixed paper sizes or sizes larger than A4, 8¹/₂"× 11" is set, it will only be collated, even if Rotating Collate has been selected.
- If tab sheets are used, Rotating Collate will not work.
- When Cover/Slip Sheet or Chaptering has been selected, Collate or Shift Collate will occur even if Rotating Collate has been selected.
- When Rotating Collate has been selected, printing speed will be slower than with other collate functions.
- When setting Collate in the printer driver settings, make sure that a collate option is not selected in the print settings of the application. If a collate option is selected, printing will not occur as intended.

 **Reference**

For information about paper sizes and the number of sets you can use Collate, Rotating Collate, and Shift Collate in every option, see *Copy Reference*.

For printing methods, see the printer driver Help.

Spool Printing

Spool Printing allows print jobs transferred from a computer to be temporarily stored, and then prints them after they are transferred. This shortens printing time as it maximizes printer efficiency.

Important

- During Spool Printing, the hard disk is accessed and the Data-In indicator blinks. Turning off the computer or machine during Spool Printing can damage the hard disk. Also, if the computer or machine is turned off during Spool Printing, spooled jobs will be deleted. Do not turn the power to the computer or machine off during Spool Printing.

Limitation

- If data is sent to the machine using other protocols besides LPR, IPP or SMB, spool printing cannot be performed.
- Up to a maximum of 150 jobs at once can be spool printed.

Note

- Printing the first page with Spool Printing will be slow.
- The computer requires less print processing time, when large amounts of data are spooled.
- Spool jobs stored in the machine can be viewed or deleted using a Web browser.

Viewing/Deleting spool jobs in a Web browser

Start the Web browser and enter the machine's IP address in the address bar. This displays the top page.

Example : `http://192.168.155.160`

(In this example, the IP address of the machine is 192.168.155.160)

Click **[Admin Info]**, and then click **[Spool Printing Job List (Printer)]** to display the spool jobs. To delete, check the box next to the name of the file you want to delete. Enter the password ^{*1}, and then click **[Delete]**. For more information, see *Network Guide*.

^{*1} The default password is "password".

 **Setting Spool Printing**

Spool Printing can be set using telnet or a Web browser.

- Using a Web browser
Click [**Configuration**], and then click [**General**]. Set [**Spool Printing**] to [**Enable**].
See *Network Guide* or Help for more information.
 - Using telnet
Enter “spoolsw spool on” to set Spool Printing.
See *Network Guide* for more information about telnet.
- 

Covers

Using this function, you can insert cover and back sheets, feeding from a different tray from that of the paper for the body, and print on them as well.



Reference

For printing methods, see the printer driver's Help.

Limitation

- To use this function, Collate must be set. Rotating Collate cannot be set.
- This function is not available with the PostScript printer driver.

Note

- The cover sheets should be the same size and orientation as the body of the paper.
- If "Auto Tray Select" has been set as the paper feed tray for the body paper, the paper will be delivered from a tray containing paper in  orientation. Therefore, when the cover paper has been set to  orientation, the orientation of the output cover paper and body paper will be different.

Cover sheet

Prints the first page of the document on the sheet for the cover page.

- Print on one side
 - Prints on one side of the cover sheet only, even when duplex printing is selected.

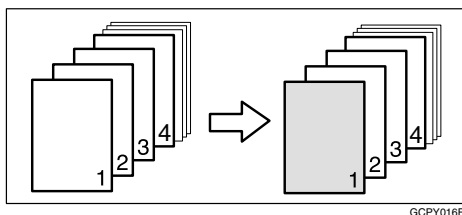

- Print on both sides
 - Prints on both sides of the cover sheet when duplex printing is selected.

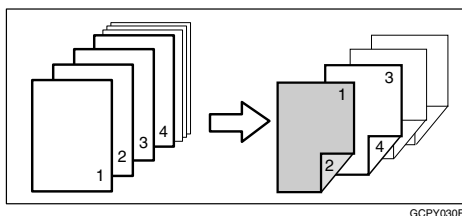

- Blank

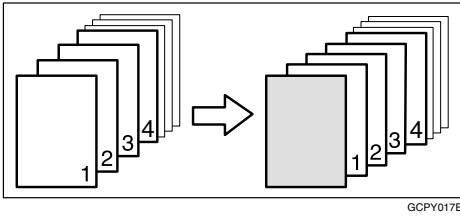

❖ **Front/Back Covers**

Prints the first and last page of the document on the sheet for the cover and back cover pages.

- Print on one side

Prints on the one side of the cover sheets only, even when duplex printing is selected.

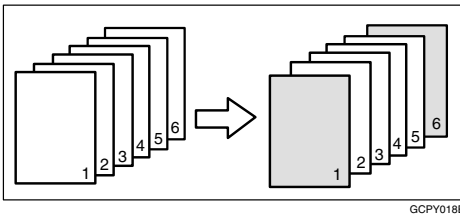

- Print on both sides

Prints on both sides of the cover sheets when duplex printing is selected.

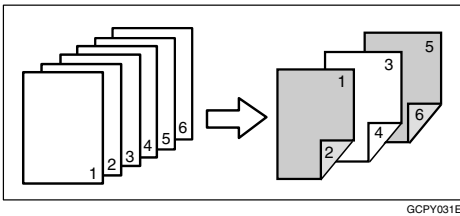

- Blank

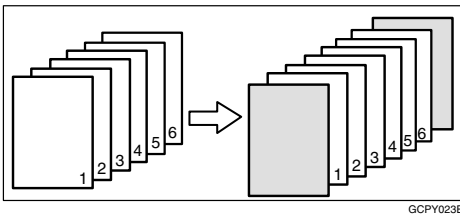

Slip Sheets

! Limitation

- This function cannot be used with the PostScript printer driver under Windows 2000/XP, Windows NT 4.0, Mac OS or Mac OS X.

❖ Inserting a slip sheet between each page

- Print

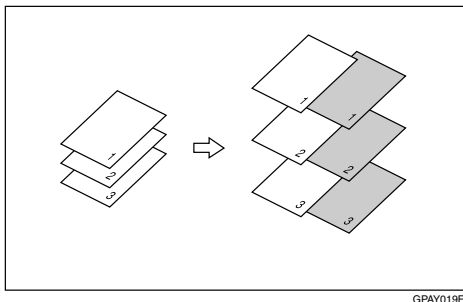

- Blank

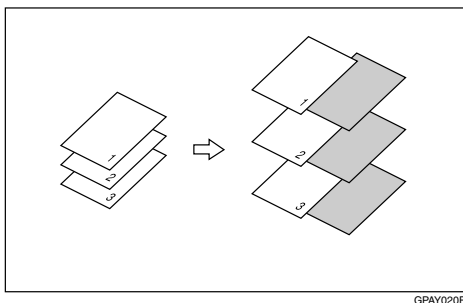

❖ Inserting a slip sheet between OHP transparencies

- Print

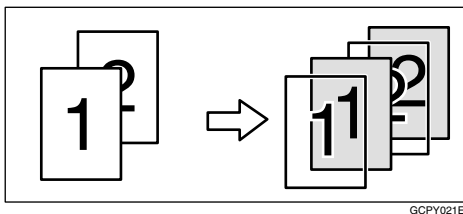

- Blank

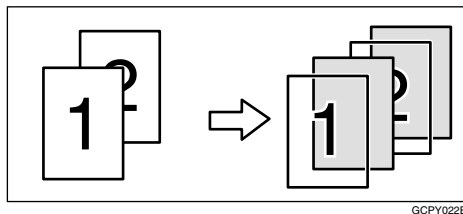

 **Note**

- Collate cannot be set.
- Slip sheets cannot be inserted while duplex printing.
- The slip sheet should be the same size and orientation as the body of the paper.
- The same paper feed tray cannot be set for the body of the document and the slip sheet.

Chaptering

A specified page is printed on the same side as the first page, like a book. Also, you can insert chapter slip sheets before specified pages, and select whether or not to print on the slip sheets.

! Limitation

- This function is available with the PCL and RPCS™ printer driver.

🔍 Reference

For printing methods, see the printer driver Help.

📝 Note

- Up to 100 pages can be specified as the front pages of chapters using the printer driver.

❖ No slip sheets

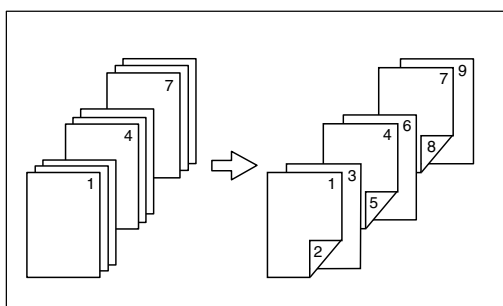

GCPY024E

📝 Note

- This function is only valid with duplex printing.
- This function can be used together with combine (layout) printing.

❖ Inserting chapter slip sheets

- Print
 - Prints on the chapter slip sheets. When duplex printing is selected, both sides of the slip sheets are printed on.

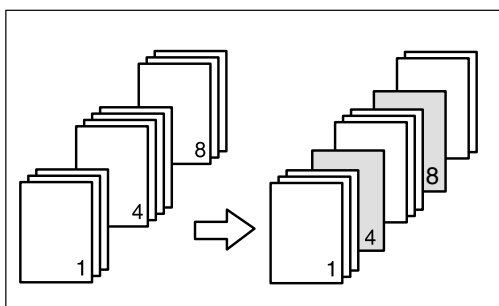

GCPY026E

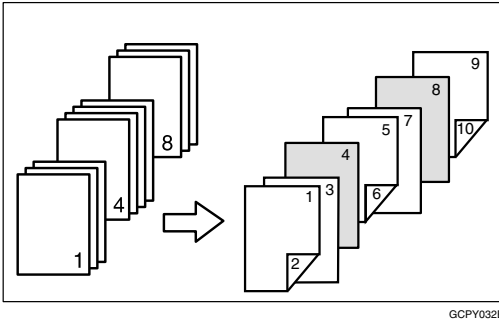

- **Print on front side only**
Prints on the front side of chapter slip sheets even if duplex printing is selected.

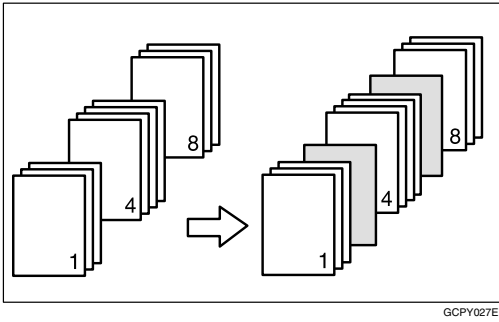

- **Blank**



 **Note**

- The slip sheet should be the same size and orientation as the body of the paper.
- If Auto Tray Select has been set as the paper feed tray for the body paper, paper will be delivered from a tray containing paper in  orientation. Therefore, when the cover paper has been set to  orientation, the orientation of printed cover paper and body paper will be different.
- The same paper feed tray cannot be set for the body of the document and the slip sheet.

User Defined Pages

Using this function, you can specify paper ranges for each input tray.

Reference

For printing methods, see the printer driver Help.

Limitation

- This function is available with the PCL printer driver only.
- If **[Document Server]** is selected under **[Job Type]**, User Defined Page cannot be used.
- If **[User Defined Pages]** is selected under **[Paper]**, **[Layout]** and **[Duplex]** cannot be selected.

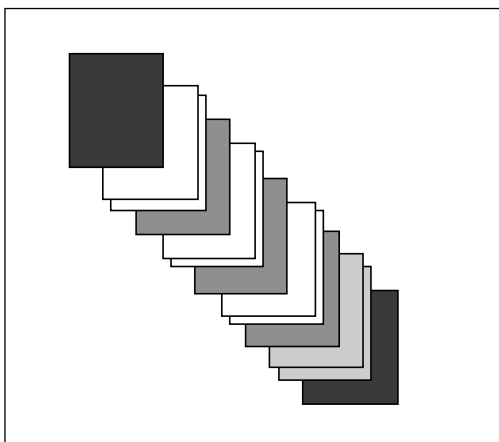

GCPY500E

Separation Sheet





Using this function, you can insert a separation sheet between each set when printing multiple sets of documents such as meeting materials.

Reference

For printing methods, see the printer driver Help.

Specifications

This section contains the electrical and hardware specifications of the machine, including information about the options.

Component	Specifications
Resolution	PCL 6 : 600 dpi, 1200 dpi PCL 5e: 300 dpi, 600 dpi RPCS™ : 200 dpi, 300 dpi, 600 dpi, 1200 dpi PostScript 3 : 300 dpi *1, 600 dpi, 1200 dpi
Printing speed	90 ppm/105 ppm (A4  , 8½" × 11"  plain paper)  Note <input type="checkbox"/> Printing speeds depend on the machine. Check which type of machine you have. See <i>General Settings Guide</i> .
Interface	Standard: <ul style="list-style-type: none"> IEEE 1284 parallel interface Type C  Note <input type="checkbox"/> Use a standard Micro Centronics 36 pin cable not longer than 3 meters (10 feet). <ul style="list-style-type: none"> Ethernet interface (100 BASE-TX/10BASE-T) Option: <ul style="list-style-type: none"> IEEE 1394 interface IEEE 802.11b wireless LAN interface USB 2.0 interface
Network protocol	TCP/IP, IPX/SPX, NetBEUI *2, AppleTalk
Printer language	Standard: PCL 6, PCL 5e, RPCS™ Option: PostScript 3
Fonts	PCL 6/5e : Afga Monotype Font Manager 35 Intellifonts, 10 TrueType fonts, and 1 Bitmap font Font Manager available. PostScript 3 : 136 fonts (Type 2:24, Type 14:112)
Memory	384 MB
Hard disk	80 GB

Component	Specifications
Operating systems supported by this machine	Windows 95/98/Me Windows 2000 Windows XP Windows NT 4.0 Mac OS 8.6 to 9.2 Mac OS X
Network cable	100BASE-TX/10BASE-T shielded twisted-pair (STP, Category/Type5) cable.

*1 300 dpi cannot be selected by printer driver.

*2 To use NetBEUI, use the SmartNetMonitor for Client port.

Options

IEEE 1394 Interface Board Type B

❖ **Transmission spec.:**

IEEE 1394

❖ **Interface:**

IEEE std 1394-1995 compliant

IEEE std 1394a-2000 compliant

❖ **Device class:**

SCSI print (Windows 2000, Windows XP)

IP over 1394 (Windows Me, Windows XP)

❖ **Protocol:**

SBP-2 (SCSI print)

TCP/IP (IP over 1394)

❖ **Interface connector:**

IEEE 1394 (6 pin × 2)

❖ **Required cable:**

1394 interface cable (6 pin × 4 pin, 6 pin × 6 pin)

 **Important**

You cannot plug devices together to create loops.

Do not use a cable more than 4.5 meters long.

❖ **Data transfer speed:**

Maximum 400 Mbps

- ❖ **Connectable number of devices on a bus:**
Maximum 63
- ❖ **Allowed cable hops on a bus:**
Maximum 16
- ❖ **Power supply:**
Non power supply
Cable Power repeated (IEEE 1394a-2000 compliant)

IEEE 802.11b Interface Unit Type C

- ❖ **Transmission spec.:**
Based on IEEE 802.11b (wireless LAN)
- ❖ **Protocol:**
TCP/IP, NetBEUI, IPX/SPX, AppleTalk



Note

- SmartNetMonitor and Web browser are supported.

- ❖ **Data transfer speed:**
Auto select from below speed
1Mbps, 2Mbps, 5.5Mbps, 11Mbps
- ❖ **Frequency range:**
 - Inch version:
2400-2497 MHz (1-11 channels)
 - Metric version:
2400-2497 MHz (1-13 channels)

- ❖ **Transmittable distance:**

1Mbps 400 m ^{*1}
 2Mbps 270 m ^{*1}
 5.5Mbps 200 m ^{*1}
 11Mbps 140 m ^{*1}

^{*1} These figures are a guideline for outdoor use. In general, the transmittable distance indoors is 10-100 m, depending on environment.

- ❖ **Transmission mode:**
802.11 Ad hoc, Ad hoc, and Infrastructure mode

USB2.0 Interface Board Type B

❖ **Transmission spec:**

Based on USB 2.0

❖ **Data transfer speed:**

High Speed: 480 Mbps

Full Speed: 12 Mbps

❖ **Supported operating system:**

Windows 98 SE/Me, Windows 2000/XP, Mac OS 9.x, Mac OS X Classic mode

 **Note**

- This USB 2.0 interface board is compatible with devices that support USB 1.1.
- For Windows 98 SE/Me, make sure to install USB Printing Support included on the CD-ROM that comes with this machine. When USB 2.0 is used with Windows 98 SE/Me, only a speed equal to that of USB 1.1 is possible.
- Macintosh supports only the standard USB port.

PostScript 3 Unit Type 2105

 **Reference**

See *PostScript 3 Unit Type 2105 Operating Instructions Supplement* for information.

INDEX

C

- Canceling a job
 - Macintosh*, 9
 - Windows*, 8
- Chaptering, 59
- Collate, 51
- Configuration page, 34
- Control panel
 - locked print*, 13
 - printer features, adjusting*, 31
 - sample print*, 13
- Covers, 55

D

- Data In indicator, 26, 28, 29
- Display panel
 - error messages*, 23
- Document Server, 11

E

- Error messages, 23

F

- Finisher, 45
- Fonts, 63

H

- Hard disk, 63
- Host Interface, 41

I

- IEEE 1394 Interface Board Type B, 64
- IEEE 802.11b Interface Unit Type C, 65
- Interface, 63

L

- List/Test Print, 34
- Locked print, 16
 - deleting*, 18

M

- Macintosh
 - canceling a job*, 9
 - setting up, printer driver*, 7
- Maintenance, 37
- Memory, 63

N

- Network Cable, 64
- Network protocol, 63

O

- Operating system, 64
- Options, 64

P

- PCL menu, 41
- PostScript 3 Unit Type 2105, 66
- Printer driver
 - Printer properties, Windows 2000/XP*, 4
 - Printer properties, Windows 95/98/Me*, 3
 - Printer properties, Windows NT 4.0*, 5
 - setting up, Macintosh*, 7
- Printer features
 - adjusting*, 33
 - menu*, 31
 - parameters*, 34
- Printer Language, 63
- Printing speed, 63
- Punch, 49

R

- Resolution, 63

S

- Sample print, 13
 - deleting*, 15
- Slip Sheets, 57
- Specifications, 63
- Spool printing, 53
- Staple, 46
- System, 38

T

- Troubleshooting, 23
 - error messages*, 23
 - machine does not print*, 24
 - other printing problems*, 27
 - status messages*, 23

U

- USB2.0 Interface Board Type B, 66

W

- Windows
 - cancelling a job*, 8
- Windows 2000/XP
 - printer properties, printer driver*, 4
- Windows 95/98/Me
 - printer properties, printer driver*, 3
- Windows NT 4.0
 - printer properties, printer driver*, 5

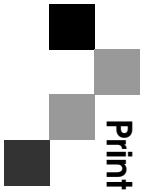

Printer/Scanner Unit Type 2105 Operating Instructions Printer Reference 2